

# PC 100/125 HT



Sample image

**Order symbol:** PC 100/125 HT

**Product nbr:** 6011904

UL Code: 6411904

UL Name: UL PC 100/125HT

**Description:** Enclosure. PC

**Remarks:** Smoked transparent cover

**Including:** Base with TPE gasket, screws for mounting plate/DIN-rail and cover with polyamide cover screws.

**EAN:** 6418074022301

**El. number:**

- Finland: 3420425
- Denmark: 8212022357
- Sweden: 2535618

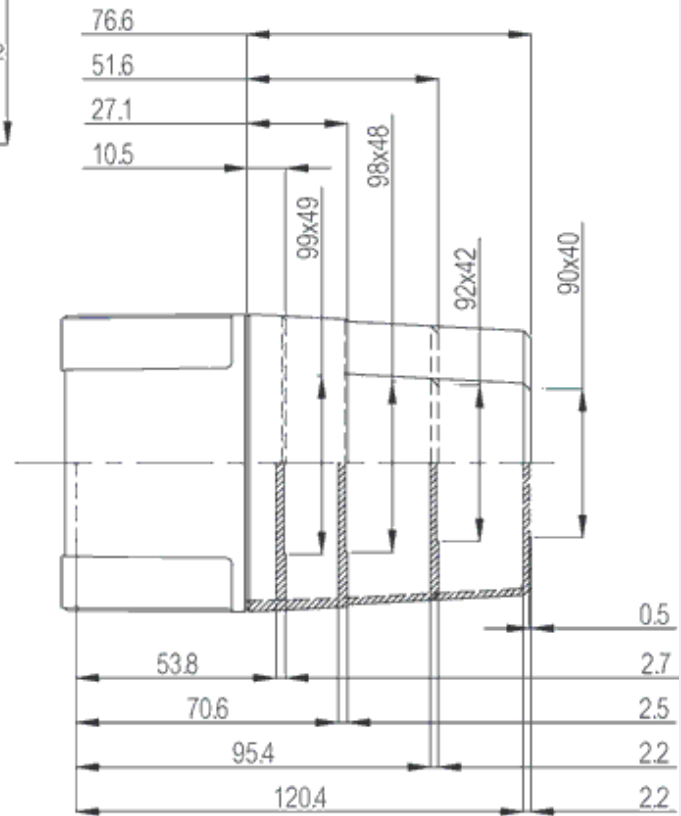
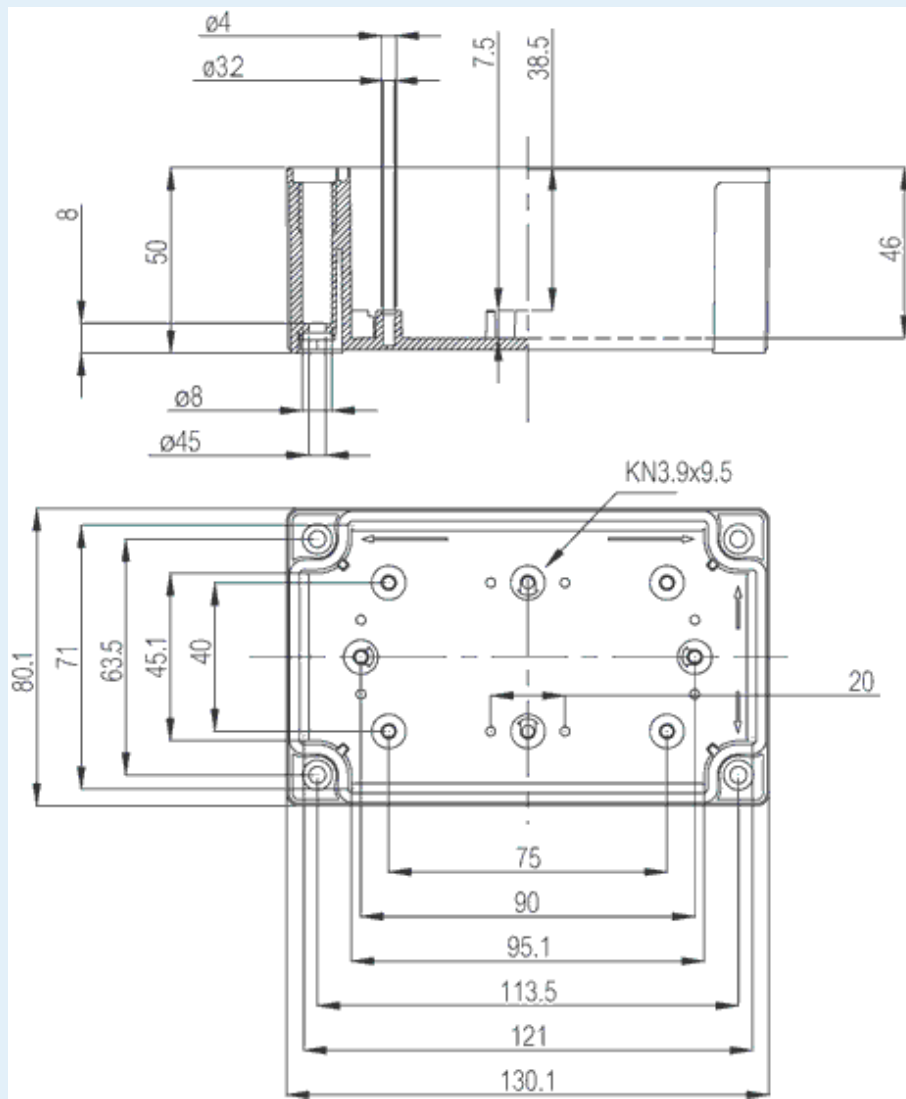

**Dimensions:**      **Height**      **Width**      **Depth**

mm:                      130                      80                      125  
 inch:

**Materials:**

Material:                      Polycarbonate  
 Base colour:                      RAL 7035 -light grey  
 Cover colour:                      Clear transparent  
 Gasket material:                      Polyurethane

**Temperatures:**

Temperature °C (short term)::                      -40 ... 120  
 Temperature °C (continuous):                      -40 ... 80  
 Temperature °F (short term):                      -40 ... 250  
 Temperature °F (continuous):                      -40 ... 175

**Accessories:**

MIV 10                      DIN-35 Mounting rail. for enclosures:  
 (100 x 35 x 1)  
 MIV 5                      DIN-35 Mounting rail. for enclosures:  
 (50 x 35 x 1)  
 HFP 130                      Front panel hinge series for FP A 100-125  
 MIN 5                      DIN-15 Mounting rail. for enclosures:  
 (50 x 15 x 1)  
 MIV 100                      Back Panel (Galvanized steel). for enclosures:  
 (98 x 48 x 1)  
 MIN 10                      DIN-15 Mounting rail. for enclosures:  
 (100 x 15 x 1)  
 FP 22046                      Mounting foot kit (4 pcs)  
 FP A 100/130                      Front panel (Aluminum). for enclosures:  
 (120 x 62 x 1)

**Rating:**

Ingress protection (EN 60529):                      IP66; IP67;  
 Impact Resistance (EN 62262):                      IK08;  
 Electrical insulation:                      Totally insulated  
 Halogen free (DIN/VDE 0472, Part 815):                      1  
 UV resistance:                      UL 508

Flammability Rating: UL 746C 5"

Glow Wire Test (IEC 695-2-1) °C: 960 °C

NEMA Class

**Certificates:**

Certificate FI 40847